

BLF 5.08HC/20/180 SN OR BX

Weidmüller Interfaces GmbH & Co. KG

Postfach 3030

32760 Detmold

Tel. +49 5231 14-0

Fax. +49 5231 14-2083

info@weidmueller.com

www.weidmueller.com

Product image



Similar to illustration

Just as reliable as the millionfold proven original and featuring innovative details:

The BLF 5.08HC PUSH IN version of the BLZP 5.08HC female connector is not only different in terms of connection system; it also has a more compact design. Weidmüller's innovative PUSH IN spring connection system stands for the future of easy and tool-free wire connection. HC = High Current.

In terms of versatility, the BLF 5.08HC offers just as much as the version which served as a model:

- 3 tested-and-proven wire outlet directions provide the usual flexibility for application-specific design
- 4 flange variations and the patented release latch allow the locking concept to be based on the requirements of the user
- Use the BLF 5.08HC and SL 5.08HC plug combination to reach the max. rated specifications

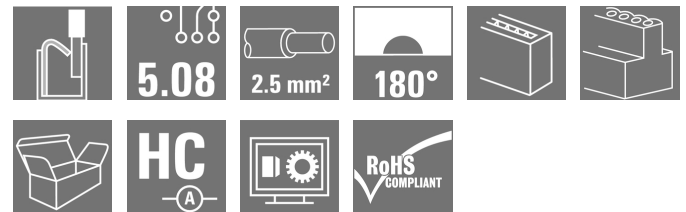

General ordering data

Version	PCB plug-in connector, female plug, 5.08 mm, Number of poles: 20, 180°, PUSH IN, Spring connection, Clamping range, max. : 3.31 mm², Box
Order No.	1013880000
Type	BLF 5.08HC/20/180 SN OR BX
GTIN (EAN)	4032248721986
Qty.	18 pc(s).
Product data	IEC: 400 V / 24 A / 0.2 - 2.5 mm² UL: 300 V / 18.5 A / AWG 26 - AWG 12
Packaging	Box

BLF 5.08HC/20/180 SN OR BX

Weidmüller Interfaces GmbH & Co. KG

Postfach 3030

32760 Detmold

Tel. +49 5231 14-0

Fax. +49 5231 14-2083

info@weidmuller.com

www.weidmuller.com

Technical data**Dimensions and weights**

Depth	27.7 mm	Depth (inches)	1.091 inch
Height	14.2 mm	Height (inches)	0.559 inch
Net weight	36.607 g	Width	101.6 mm
Width (inches)	4 inch		

System Parameters

Product family	OMNIMATE Signal - series BL/SL 5.08	Type of connection	Field connection
Wire connection method	PUSH IN, Spring connection	Pitch in mm (P)	5.08 mm
Pitch in inches (P)	0.2 inch	Conductor outlet direction	180°
Number of poles	20	L1 in mm	96.52 mm
L1 in inches	3.8 inch	Number of rows	1
Pin series quantity	1	Rated cross-section	2.5 mm ²
Touch-safe protection acc. to DIN VDE 57 106	Safe from finger touch	Touch-safe protection acc. to DIN VDE 0470	IP 20
Volume resistance	≤5 mΩ	Can be coded	Yes
Stripping length	10 mm	Screwdriver blade	0.6 x 3.5
Screwdriver blade standard	DIN 5264	Plugging cycles	25
Plugging force/pole, max.	7 N	Pulling force/pole, max.	5.5 N

Material data

Insulating material	PBT	Colour	orange
Colour chart (similar)	RAL 2000	Insulating material group	IIIa
Comparative Tracking Index (CTI)	≥ 200	Insulation strength	≥ 10 ⁸ Ω
UL 94 flammability rating	V-0	Contact material	CuSn
Contact surface	tinned	Layer structure of plug contact	4...8 μm Sn hot-dip tinned
Storage temperature, min.	-40 °C	Storage temperature, max.	70 °C
Operating temperature, min.	-50 °C	Operating temperature, max.	100 °C
Temperature range, installation, min.	-30 °C	Temperature range, installation, max.	100 °C

Conductors suitable for connection

Clamping range, min.	0.13 mm ²	Clamping range, max.	3.31 mm ²
Wire connection cross section AWG, min.	AWG 26	Wire connection cross section AWG, max.	AWG 12
Solid, min. H05(07) V-U	0.2 mm ²	Solid, max. H05(07) V-U	2.5 mm ²
Flexible, min. H05(07) V-K	0.2 mm ²	Flexible, max. H05(07) V-K	2.5 mm ²
w. plastic collar ferrule, DIN 46228 pt 4, min.	0.25 mm ²	w. plastic collar ferrule, DIN 46228 pt 4, max.	2.5 mm ²
w. wire end ferrule, DIN 46228 pt 1, min.	0.25 mm ²	w. wire end ferrule, DIN 46228 pt 1, max.	2.5 mm ²
Plug gauge in accordance with EN 60999 a x b; ø	2.8 mm x 2.0 mm	Reference text	The outside diameter of the plastic collar should not be larger than the pitch (P). Length of ferrules is to be chosen depending on the product and the rated voltage.

BLF 5.08HC/20/180 SN OR BX

Weidmüller Interfaces GmbH & Co. KG

Postfach 3030

32760 Detmold

Tel. +49 5231 14-0

Fax. +49 5231 14-2083

Technical data

Rated data acc. to IEC

tested acc. to standard	IEC 60664-1, IEC 61984	Rated current, min. number of poles (Tu=20°C)	24 A
Rated current, max. number of poles (Tu=20°C)	19 A	Rated current, min. number of poles (Tu=40°C)	21 A
Rated current, max. number of poles (Tu=40°C)	16.5 A	Rated voltage for surge voltage class / pollution degree II/2	400 V
Rated voltage for surge voltage class / pollution degree III/2	320 V	Rated voltage for surge voltage class / pollution degree III/3	250 V
Rated impulse voltage for surge voltage class/ pollution degree II/2	4 kV	Rated impulse voltage for surge voltage class/ pollution degree III/2	4 kV
Rated impulse voltage for surge voltage class/ contamination degree III/3	4 kV	Short-time withstand current resistance	3 x 1s with 120 A

Rated data acc. to CSA

Institute (CSA)		Certificate No. (CSA)	200039-1121690
Rated voltage (Use group B / CSA)	300 V	Rated voltage (Use group D / CSA)	300 V
Rated current (Use group D / CSA)	10 A	Wire cross-section, AWG, min.	AWG 26
Wire cross-section, AWG, max.	AWG 12	Reference to approval values	Specifications are maximum values, details - see approval certificate.

Rated data acc. to UL 1059

Institute (cURus)		Certificate No. (cURus)	E60693
Rated voltage (Use group B / UL 1059)	300 V	Rated voltage (Use group D / UL 1059)	300 V
Rated current (Use group B / UL 1059)	18.5 A	Rated current (Use group D / UL 1059)	10 A
Wire cross-section, AWG, min.	AWG 26	Wire cross-section, AWG, max.	AWG 12
Reference to approval values	Specifications are maximum values, details - see approval certificate.		

Packing

Packaging	Box	VPE length	35 mm
VPE width	135 mm	VPE height	350 mm

Type tests

Test: Durability of markings	Standard	DIN EN 61984 section 7.3.2 / 09.02 taking pattern from DIN EN 60068-2-70 / 07.96
	Test	mark of origin, type identification, pitch, type of material, date clock
	Evaluation	available
	Test	durability
	Evaluation	passed

BLF 5.08HC/20/180 SN OR BX

Weidmüller Interfaces GmbH & Co. KG

Postfach 3030

32760 Detmold

Tel. +49 5231 14-0

Fax. +49 5231 14-2083

DIN EN 61984 section 6.3 and 6.9.1 / 09.02,
DIN EN 60512:13-5 / 1.08

info@weidmueller.com

www.weidmueller.com

Technical data

Test: Misengagement (Non-interchangeability)

Standard	DIN EN 61984 section 6.3 and 6.9.1 / 09.02, DIN EN 60512:13-5 / 1.08
Test	180° turned with coding elements
Evaluation	passed
Test	visual examination
Evaluation	passed

Test: Clampable cross section

Standard	DIN EN 60999-1 section 7 and 9.1 / 12.00, DIN EN 60947-1 section 8.2.4.5.1 / 04.08	
Conductor type	Type of conductor and conductor cross-section	solid 0.2 mm ²
	Type of conductor and conductor cross-section	stranded 0.2 mm ²
	Type of conductor and conductor cross-section	solid 2.5 mm ²
	Type of conductor and conductor cross-section	stranded 2.5 mm ²
	Type of conductor and conductor cross-section	AWG 26/1
	Type of conductor and conductor cross-section	AWG 26/19
	Type of conductor and conductor cross-section	AWG 14/1
	Type of conductor and conductor cross-section	AWG 14/19
Evaluation	passed	

BLF 5.08HC/20/180 SN OR BX

Weidmüller Interfaces GmbH & Co. KG

Postfach 3030

32760 Detmold

Tel. +49 5231 14-0

Technical data

Fax. +49 5231 14-2083

Test for damage to and accidental loosening of conductors

Standard	DIN EN 60999-1 section 9.4 / 12.00
Requirement	0.2 kg info@weidmueller.com
Conductor type	Type of conductor and conductor cross-section AWG 26/1
	Type of conductor and conductor cross-section AWG 26/19
Evaluation	passed
Requirement	0.3 kg
Conductor type	Type of conductor and conductor cross-section H05V-U0.5
	Type of conductor and conductor cross-section H05V-K0.5
Evaluation	passed
Requirement	0.7 kg
Conductor type	Type of conductor and conductor cross-section H07V-U2.5
	Type of conductor and conductor cross-section H07V-K2.5
Evaluation	passed
Requirement	0.9 kg
Conductor type	Type of conductor and conductor cross-section AWG 12/1
	Type of conductor and conductor cross-section AWG 12/19
Evaluation	passed

BLF 5.08HC/20/180 SN OR BX

Weidmüller Interfaces GmbH & Co. KG

Postfach 3030

32760 Detmold

Tel. +49 5231 14-0

Technical data

Fax. +49 5231 14-2083

Pull-out test	Standard	DIN EN 60999-1 section 9.5 / 12.00	
	Requirement	≥10 N info@weidmueller.com	
Conductor type	Type of conductor and conductor cross-section	AWG 26/1	and conductor cross-section
	Type of conductor and conductor cross-section	AWG 26/19	
Evaluation	passed		
Requirement	≥20 N		
Conductor type	Type of conductor and conductor cross-section	H05V-K0.5	
	Type of conductor and conductor cross-section	H05V-U0.5	
Evaluation	passed		
Requirement	≥50 N		
Conductor type	Type of conductor and conductor cross-section	H07V-U2.5	
	Type of conductor and conductor cross-section	H07V-K2.5	
Evaluation	passed		
Requirement	≥60 N		
Conductor type	Type of conductor and conductor cross-section	AWG 12/1	
	Type of conductor and conductor cross-section	AWG 12/19	
Evaluation	passed		

Classifications

ETIM 6.0	EC002638	ETIM 7.0	EC002638
eClass 9.0	27-44-03-09	eClass 9.1	27-44-03-09
eClass 10.0	27-44-03-09	eClass 11.0	27460202

Important note

IPC conformity Conformity: The products are developed, manufactured and delivered according international recognized standards and norms and comply with the assured properties in the data sheet resp. fulfill decorative properties in accordance with IPC-A-610 "Class 2". Further claims on the products can be evaluated on request.

Approvals

Approvals



ROHS	Conform
UL File Number Search	E60693

BLF 5.08HC/20/180 SN OR BX

Weidmüller Interfaces GmbH & Co. KG

Postfach 3030

32760 Detmold

Tel. +49 5231 14-0

Fax. +49 5231 14-2083

info@weidmueller.com

www.weidmueller.com

Technical data

Downloads

Approval/Certificate/Document of Conformity

[Declaration of the Manufacturer](#)

Brochure/Catalogue

- [FL DRIVES EN](#)
- [MB DEVICE MANUF. EN](#)
- [FL DRIVES DE](#)
- [CAT 2 PORTFOLIOGUIDE EN](#)
- [FL BUILDING SAFETY EN](#)
- [FL APPL LED LIGHTING EN](#)
- [FLIndustr.CONTROLS EN](#)
- [FL MACHINE SAFETY EN](#)
- [FL HEATING ELECTR EN](#)
- [FL APPL INVERTER EN](#)
- [FL BASE STATION EN](#)
- [FL ELEVATOR EN](#)
- [FL POWER SUPPLY EN](#)
- [FL 72H SAMPLE SER EN](#)
- [PO OMNIMATE EN](#)

Engineering Data

[STEP](#)

Engineering Data

[EPLAN, WSCAD](#)

BLF 5.08HC/20/180 SN OR BX

Weidmüller Interfaces GmbH & Co. KG

Postfach 3030

32760 Detmold

Tel. +49 5231 14-0

Fax. +49 5231 14-2083

Drawings

Dimensional drawing info@weidmueller.com

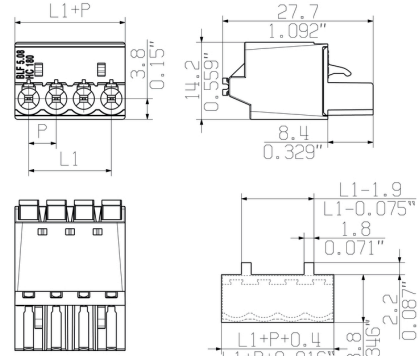

MIN. FRONT PLATE CUT-OUT

Graph

BLF 5.08HC/./180 - SL 5.08HC/./180

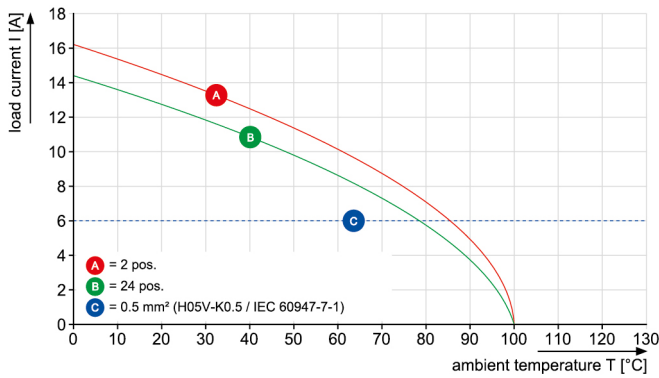

Graph

BLF 5.08HC/./180 - SL 5.08HC/./180

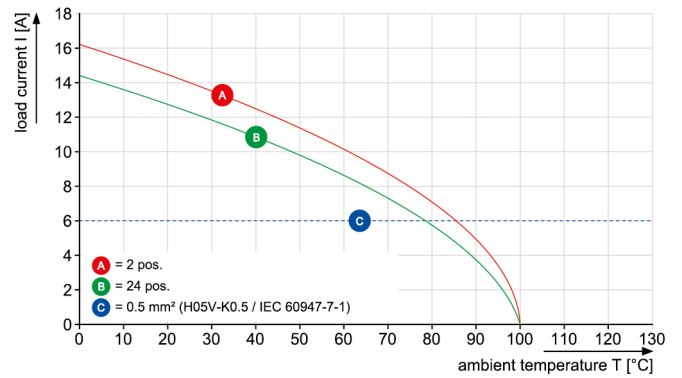

Uncompromising functionality
High vibration resistance

Data sheet

BLF 5.08HC/20/180 SN OR BX

Weidmüller Interfaces GmbH & Co. KG

Postfach 3030

32760 Detmold

Tel. +49 5231 14-0

Fax. +49 5231 14-2083

info@weidmueller.com

Drawings

Product benefits

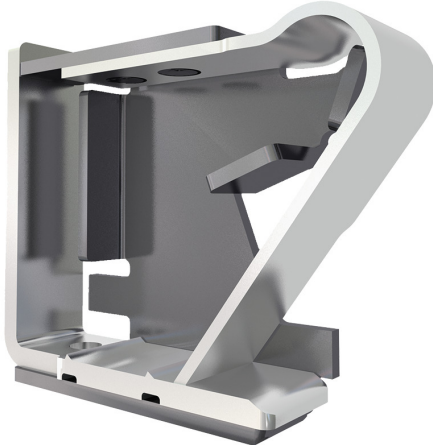

Solid PUSH IN contact
Safe and durable

Product benefits

Product benefits

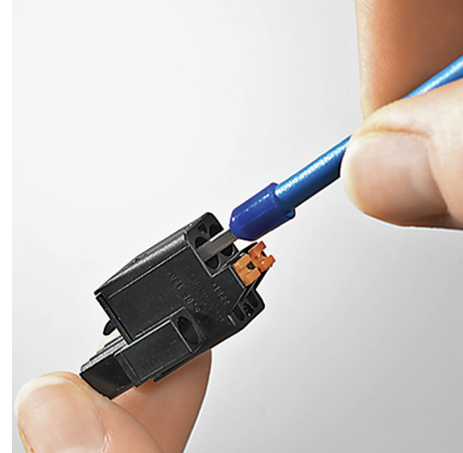

Cost-effective wiring
Quick and intuitive operation



Wide clamping range
Tool-free wire connection